

BIG FOOT METAL SYSTEMS LTD.

TECHNICAL MANUAL

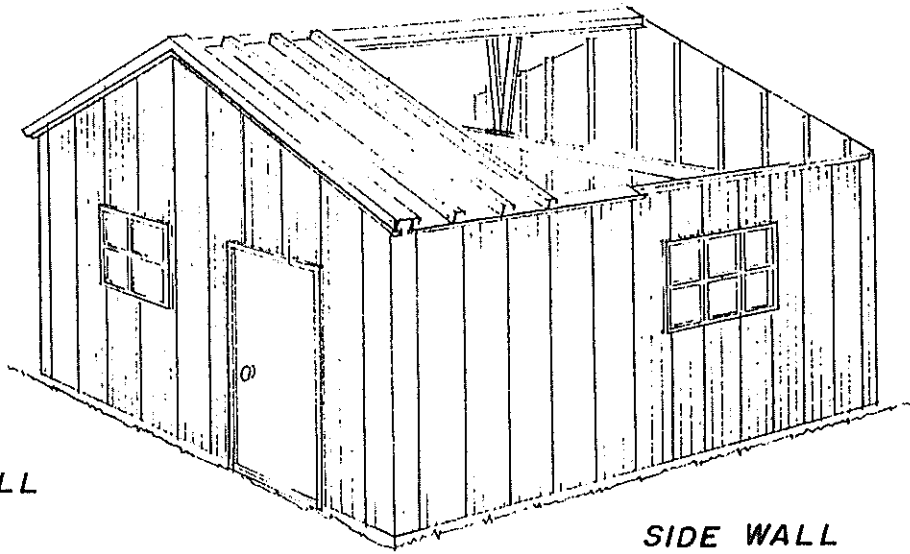

END WALL

SIDE WALL

GABLE TYPE

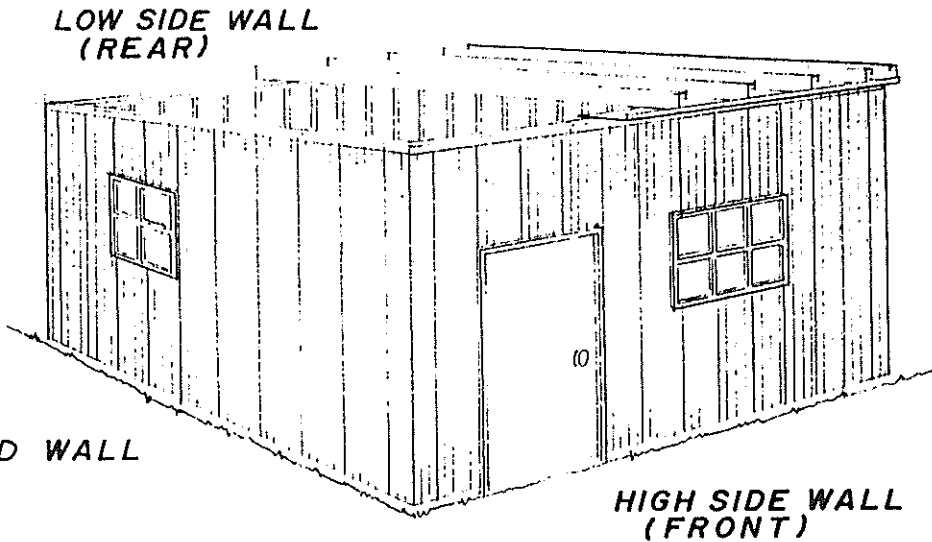

LOW SIDE WALL
(REAR)

END WALL

HIGH SIDE WALL
(FRONT)

SHED TYPE

BIG FOOT METAL SYSTEMS LTD.
BROOKS, ALBERTA

TEL. NO. 362-4181

DR'N BY
M

SCALE
N. T. S.

TITLE: *BUILDING TYPES*

DATE
APRIL '86

DWG. NO.
1

G E N E R A L N O T E S

1. Pages numbered with 'A' are ASSEMBLY INSTRUCTIONS.
2. Pages numbered with 'C' are COMPONENT IDENTIFICATION.
3. WARNING: UNTIL THE BUILDING IS COMPLETELY CLOSED IN, IT IS SUSCEPTIBLE TO WIND DAMAGE. THEREFORE, INSTALL ADEQUATE BRACING UNTIL ASSEMBLY IS COMPLETE AND KEEP WINDOW AND DOOR OPENINGS CLOSED SECURELY UNTIL INSTALLATION OF SAME IS COMPLETE.
4. Be familiar with the components by reviewing all the 'C' pages in this manual. Ensure all required components are on site prior to starting assembly to prevent delays during erection.
5. Unless noted otherwise, all drawings are views from the exterior of the building.
6. When inserting screws, DO NOT OVERTIGHTEN, as this will cause stripping of the screw or enlargement of the hole. The result is a useless connection. Insert another screw an inch or two away.
7. The 'NOTES' column on pages numbered 'C' indicate the options for material supply.
8. When assembling the building - work in a anti-clockwise direction for the base and wall panels. Complete wall panel assembly before beginning roof.
9. Anchor Bolts are NOT supplied with buldings.

BIG FOOT METAL SYSTEMS LTD. BROOKS, ALBERTA	DR'N BY	SCALE
TITLE: GENERAL NOTES	DATE APRIL/86	DWG. NO. 2

ANCHORING

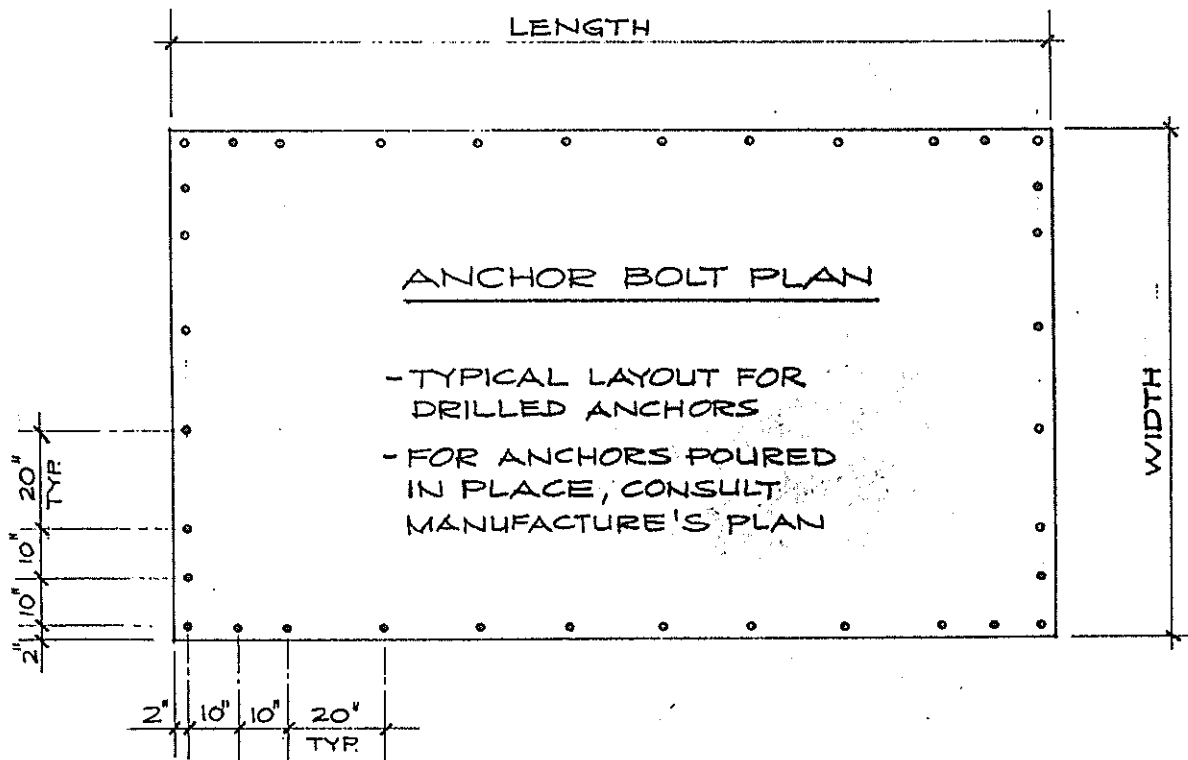

FIELD DRILLED HOLE, IN CHANNEL FLASHING TO BE MAX. $\frac{1}{16}$ " LARGER THAN ANCHOR BOLT. USE LARGE WASHER

BUTYL SEALER

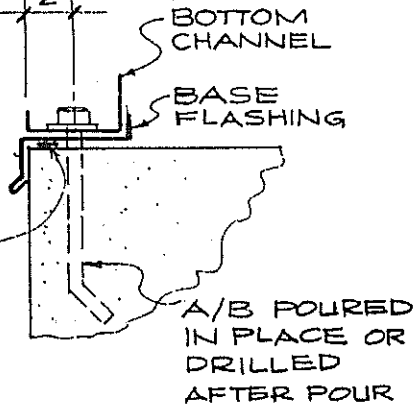

4. ANCHOR BOLTS - FOR WIND LOADS OF 20 PSF (1-kPa), A GUIDELINE FOR ANCHOR BOLT LOADS IS AS FOLLOWS FOR MOST BUILDINGS.

UPLIFT \approx 300 - 400 LBS.
SHEAR \approx 200 - 300 LBS.

NOTES:

1. PLACE BUTYL SEALER AROUND FOUNDATION.
2. PLACE BASE FLASHING OVER CAULKING. PROVIDE 3" LAP CONNECTIONS. CORNER CONNECTIONS ARE TO BE MITRED AND BUTTED, REFER DWG. A-2
3. PLACE BOTTOM CHANNEL ON BASE FLASHING. CONNECTIONS ARE BE BUTT TYPE. CORNER CONNECTIONS TO BE LAPPED AND TRIM ONE FLANGE TO FIT, REFER DWG. A-2

BIG FOOT METAL SYSTEMS LTD.
BROOKS, ALBERTA TEL. NO. 362-4181

DR'N BY
JM

SCALE
N.T.S.

TITLE: GABLE AND SHED ANCHORING

DATE
APRIL/86

DWG. NO.
A-1

BASE ASSEMBLY

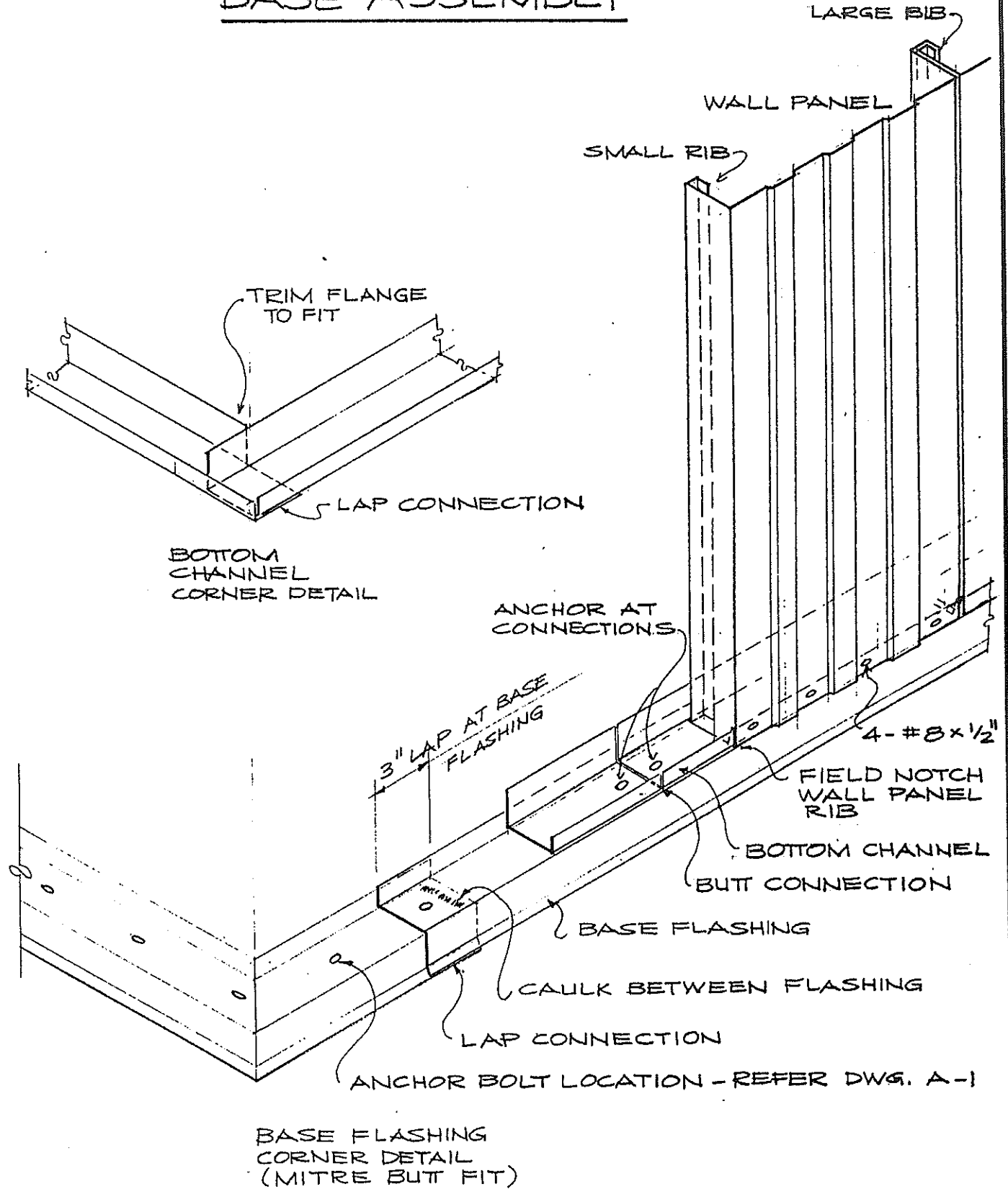

BIG FOOT METAL SYSTEMS LTD.
 BROOKS, ALBERTA TEL. NO. 362-4181

DR'N BY
 JM

SCALE
 N.T.S.

TITLE : GABLE AND SHED
 BASE ASSEMBLY

DATE
 MAR. '86

DWG. NO.
 A-2

WALL ASSEMBLY

1. DO NOT START WALL PANEL ASSEMBLY UNLESS WIND AND WEATHER CONDITIONS PERMIT.
2. LAYOUT OUT PANELS ON GROUND AROUND FOUNDATION AND NOTCH BOTTOMS TO FIT BOTTOM CHANNEL. (REFER LAYOUT DRAWING SUPPLIED WITH EACH BUILDING)

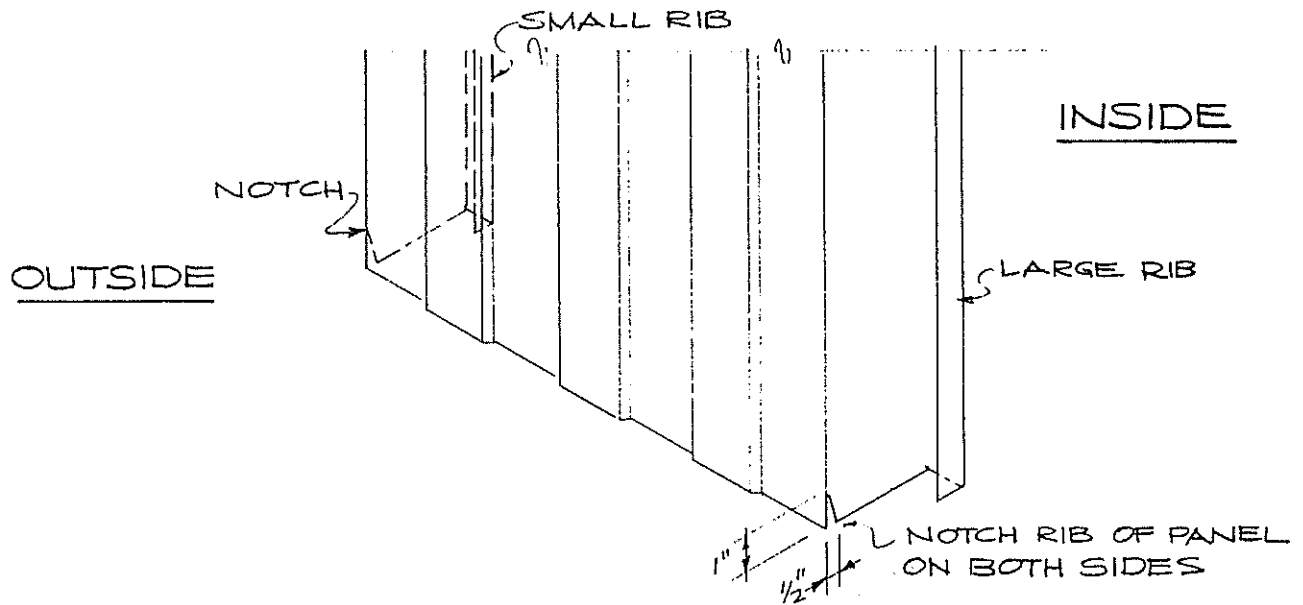
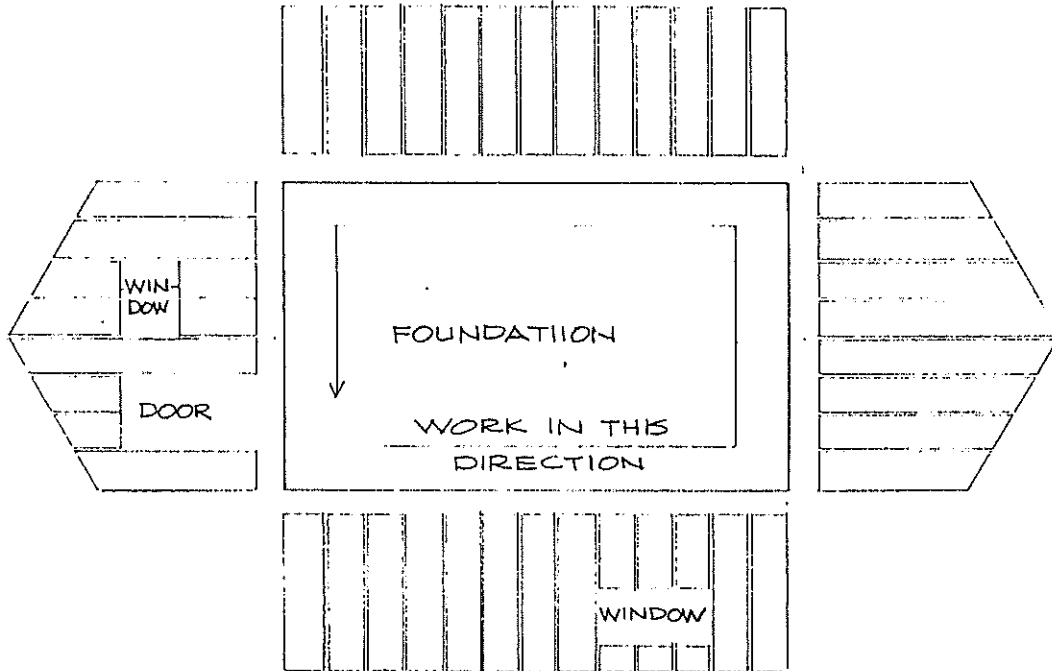

BIG FOOT METAL SYSTEMS LTD.
BROOKS, ALBERTA TEL. NO. 362-4181

DR'N BY
JM

SCALE
N.T.S.

TITLE: GABLE AND SHED
WALL ASSEMBLY

DATE
APRIL/86

DWG. NO.
A-3

3. ERECT CORNER PANELS ALONG WITH THREE WALL PANELS TO EITHER SIDE. DO NOT SCREW TOGETHER AT THIS TIME.

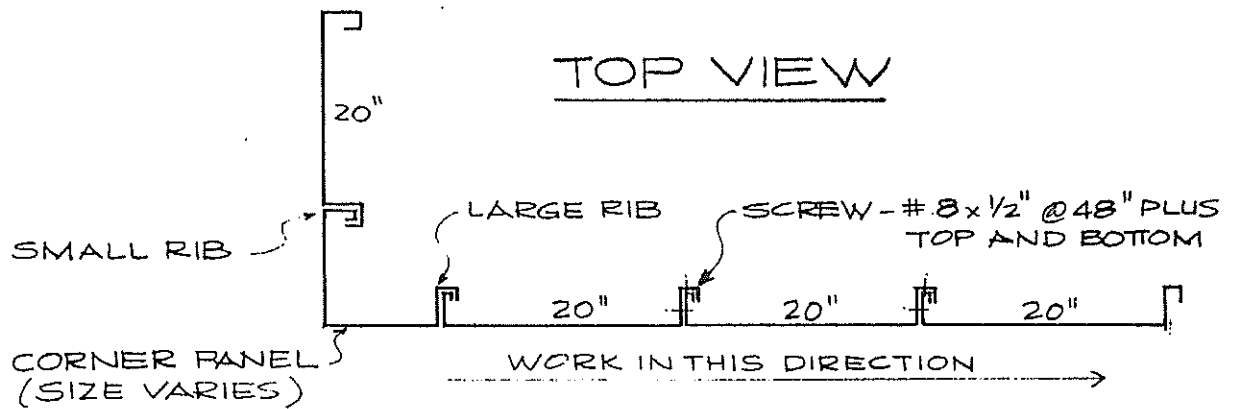

4. LEVEL AND PLUMB THESE PANELS, THEN SCREW TOGETHER WITH $\# 8 \times \frac{1}{2}$ " SCREW AT 48" SPACING BUT MAKING SURE THERE IS A SCREW 5" FROM TOP AND BOTTOM.
5. CONTINUE WALL PANEL ASSEMBLY LEFT TO RIGHT OR ANTI-CLOCKWISE AROUND PERIMETER, UNTIL ENOUGH PANELS ARE TOGETHER TO ALLOW INSTALLATION OF TOP CHANNEL, SCREW TOP CHANNEL TO WALL PANEL WITH FOUR (3) SCREWS PER PANEL. USE $\# 8 \times \frac{1}{2}$ ". TOP CHANNEL CONNECTIONS ARE TO BE BUTTED AND MADE WITH TOP CHANNEL CONNECTOR ANGLES.
6. GABLE BUILDINGS ONLY:
INSTALL TOP CHANNEL FLASHING (IF NOT ALREADY CONNECTED TO TOP CHANNEL BY MANUFACTURER) BY USING $\# 8 \frac{1}{2}$ " SCREWS SPACED AT 6" CENTER TO CENTER AND STAGGERED.

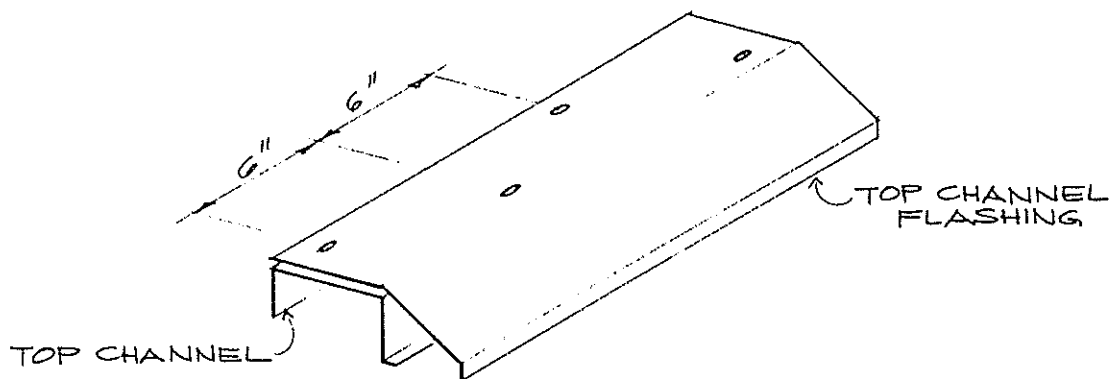

BIG FOOT METAL SYSTEMS LTD.
BROOKS, ALBERTA TEL. NO. 362-4181

DR'N BY
M

SCALE
N.T.S.

TITLE: GABLE AND SHED
WALL ASSEMBLY

DATE
APRIL/86

DWG. NO.
A-4

6A. SHED BUILDINGS ONLY :

INSTALL FRONT AND REAR TOP CHANNEL FLASHINGS (IF NOT ALREADY CONNECTED TO TOP CHANNEL BY MANUFACTURER). USE # 8 1/2" SCREWS SPACED AT 6" CENTER TO CENTER AND STAGGERED.

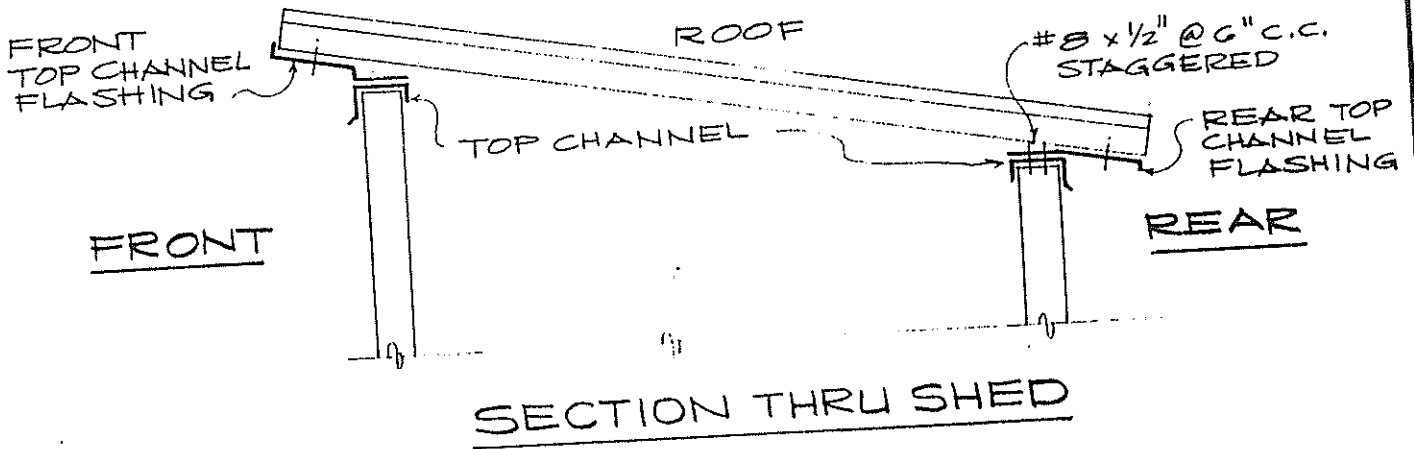

7. IF TOP CHANNEL IS MORE THAN 20' LONG, AN ANGLE SHAPED CONNECTOR IS SUPPLIED. (MAY BE FACTORY CONNECTED TO TOP CHANNEL).

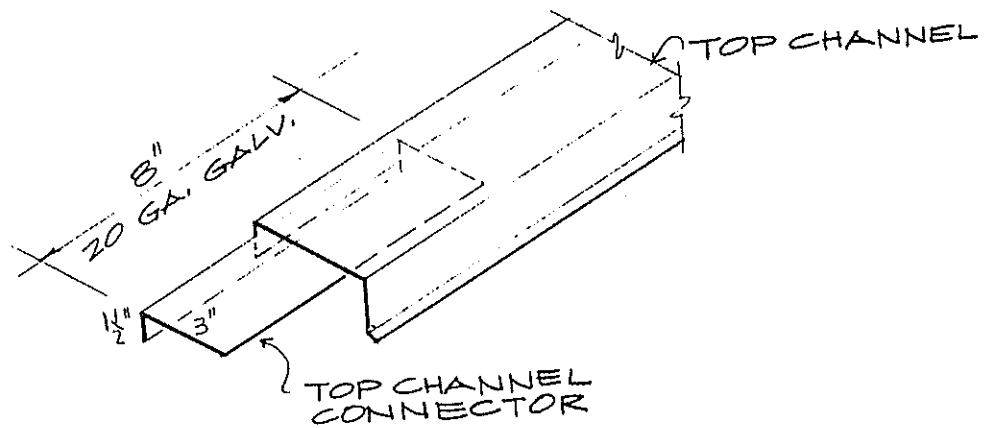

8. TOP CHANNELS ON ENDWALLS ARE TO BE NOTCHED (SIMILAR TO BOTTOM CHANNEL) AND INSTALLED OVER THE TOP CHANNEL FLASHING ON THE SIDE WALL. NO TOP CHANNEL FLASHING REQUIRED ON END WALLS.

NOTE :

TOP CHANNELS FOR END WALLS (ALL BUILDINGS) DO NOT HAVE THE 1/2" KICK OUT.

BIG FOOT METAL SYSTEMS LTD. BROOKS, ALBERTA		DR'N BY JM	SCALE N.T.S.
TEL. NO. 362-4181		DATE APRIL/86	DWG. NO. A-5
TITLE: GABLE AND SHED WALL ASSEMBLY			

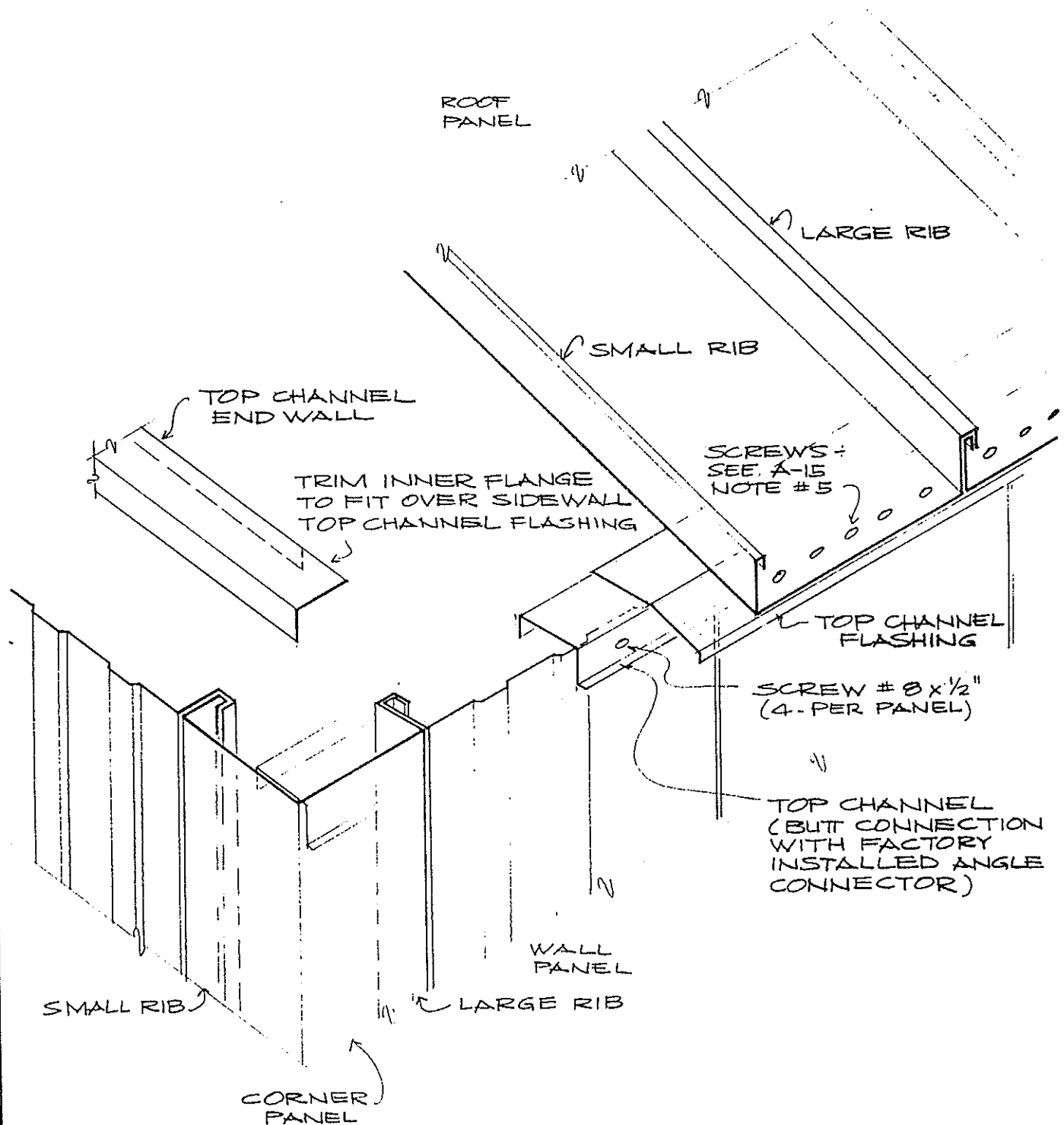

BIG FOOT METAL SYSTEMS LTD. BROOKS, ALBERTA		DR'N BY <i>M</i>	SCALE N.T.S.
TEL. NO. 362-4181		DATE APRIL/86	DWG. NO. A-6
TITLE: GABLE WALL ASSEMBLY			

GABLE - ROOF ASSEMBLY

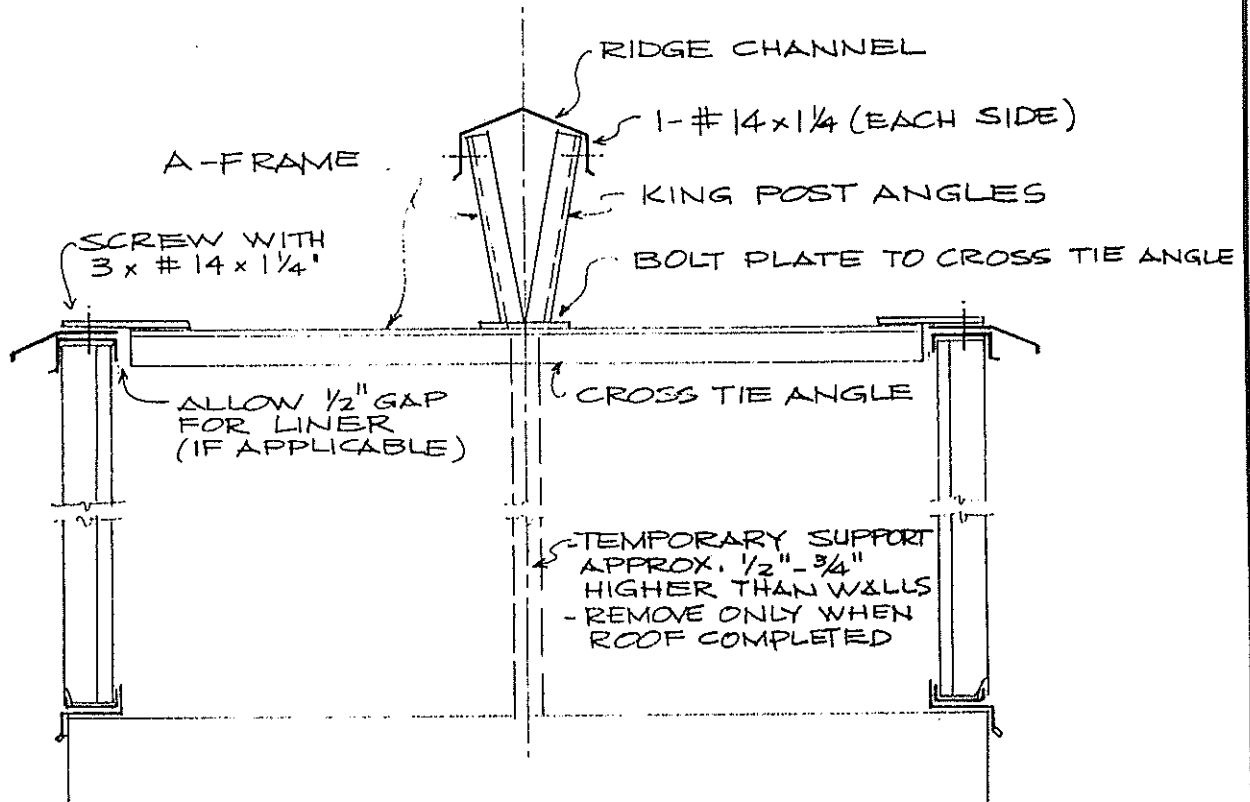

1. ERECT A-FRAME ALONG WITH RIDGE CHANNEL, PROVIDE TEMPORARY BRACING OR GUYING AS REQUIRED.
2. RIDGE CHANNEL MUST BE NOTCHED AT ENDWALLS. CONNECTIONS ARE TO BE BUTT FIT WITH RIDGE CHANNEL CONNECTOR. REFER DWG. A-8
3. SPACE A-FRAMES ACCORDING TO MANUFACTURER'S DRAWING SUPPLIED WITH BUILDING,

BIG FOOT METAL SYSTEMS LTD. BROOKS, ALBERTA Tel. No. 362-4181	DR'N BY JM	SCALE N.T.S.
TITLE: GABLE ROOF ASSEMBLY	DATE APRIL/86	DWG. NO. A-7

1. BE SURE BUILDING IS SQUARE AND WALLS ARE PLUMB BEFORE STARTING ROOF PANEL ASSEMBLY.

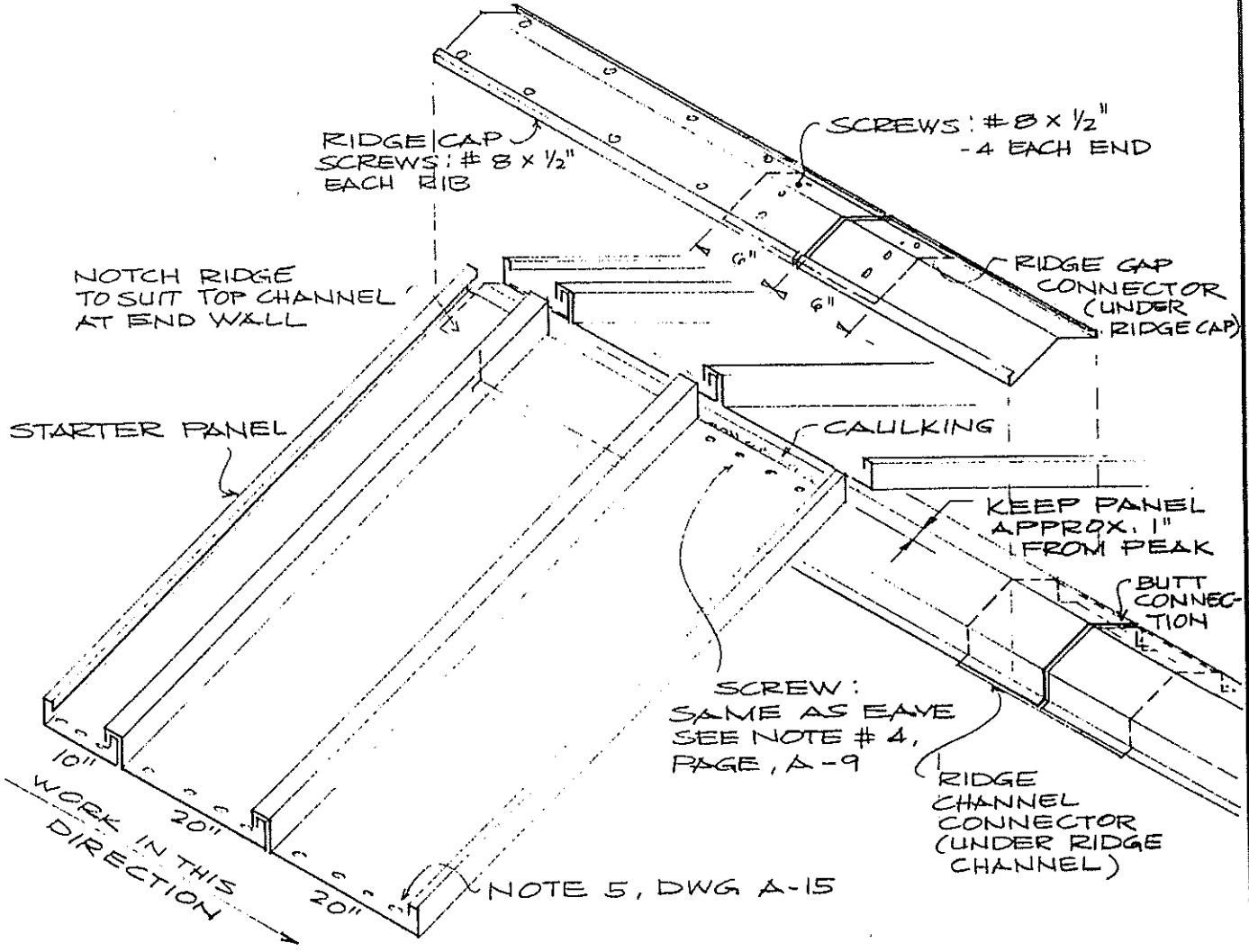

2. BEGIN BY PLACING THE STARTER PANEL FLUSH WITH THE END WALL. THE STARTER PANEL WILL USUALLY BE LESS THAN 20" WIDE AND BOTH RIBS WILL FACE INWARDS.

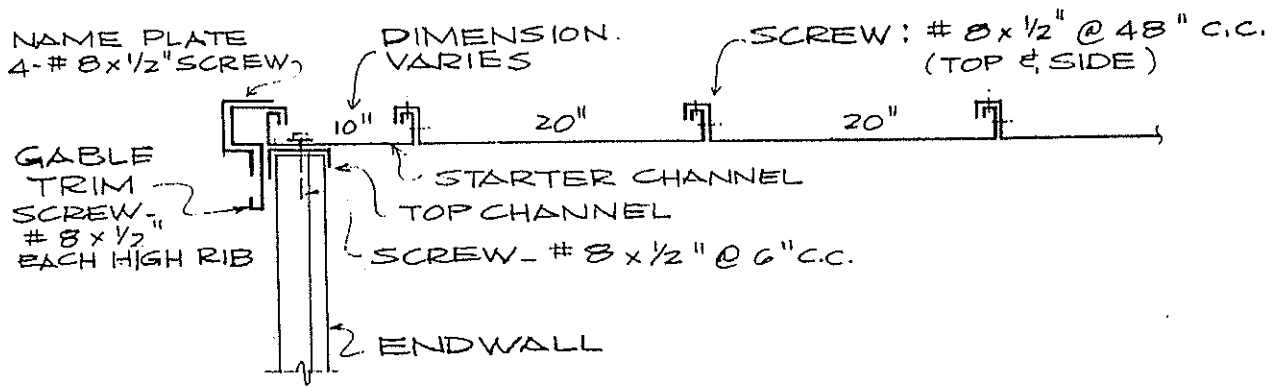

BIG FOOT METAL SYSTEMS LTD. BROOKS, ALBERTA TEL. NO. 362-4181		DR'N BY 	SCALE N.T.S.
TITLE GABLE ROOF ASSEMBLY		DATE APRIL/86	DWG. NO. A-8

3. ONCE THE STARTER PANEL IS IN PLACE, CONTINUE PLACING ROOF PANELS. BUT BE SURE PANELS ARE TOGETHER SNUGLY BEFORE SCREWING. PERIODICALLY CHECK FOR SQUARENESS.

4. ROOF PANEL TO TOP CHANNEL FLASHING

- FOR BUILDINGS UNDER 16' WIDE, USE 5-#8 x 1/2" SCREWS.

- FOR BUILDINGS OVER 16' WIDE, USE 2-#8 x 1/2" AND 3-#14 x 1/4" SCREWS.

5. EAVESTROUGH - OPTIONAL

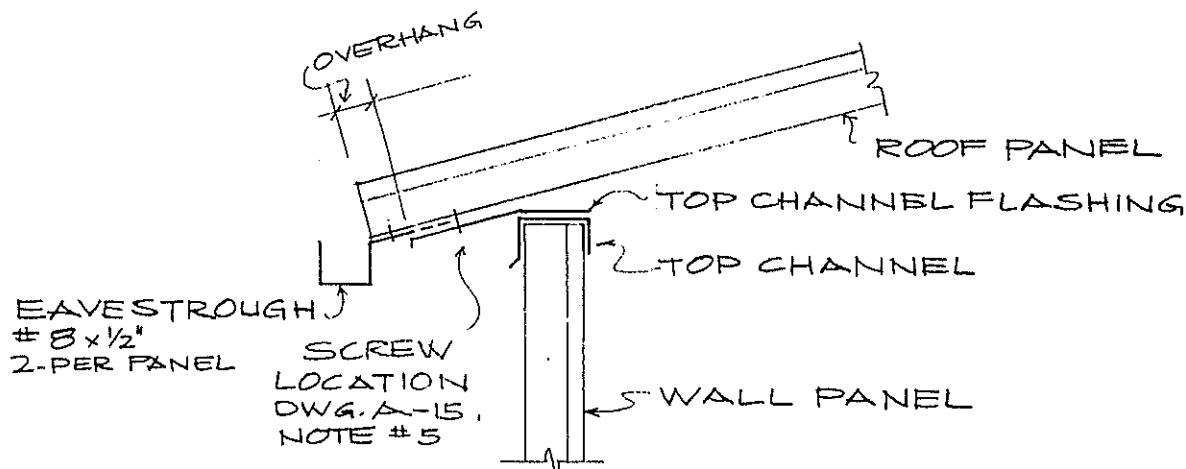

INSTALL EAVESTROUGH ENDCAPS, SCREW WITH 2-#8 x 1/2"

NOTE:

DEPENDING ON THE LENGTH OF OVERHANG, THE EAVES-TROUGH MAY HAVE TO BE INSTALLED BETWEEN THE ROOF PANEL AND TOP CHANNEL FLASHING. THEREFORE, IT WILL HAVE TO BE PLACED SIMULTANEOUSLY WITH THE ROOF PANEL.

* DOWNSPOUTING NOT SUPPLIED.

6. AFTER ALL WALL AND ROOF PANELS ARE COMPLETED; INSTALL RIDGE CAP, GABLE TRIM, GABLE TRIM END CAP, AND NAME PLATE. REF. DRWG A-8

BIG FOOT METAL SYSTEMS LTD. BROOKS, ALBERTA TEL. NO. 362-4181		DR'N BY <i>M</i>	SCALE N.T.S.
TITLE : GABLE ROOF ASSEMBLY		DATE APRIL/86	DWG. NO. A-9

SHED - ROOF ASSEMBLY

1. BE SURE BUILDING IS SQUARE AND WALLS PLUMB BEFORE STARTING ROOF PANEL ASSEMBLY.
2. BEGIN WITH THE STARTER PANEL, FLUSH WITH THE END WALL. THE STARTER PANEL WILL USUALLY BE LESS THAN 20" WIDE AND BOTH RIBS WILL FACE INWARDS.

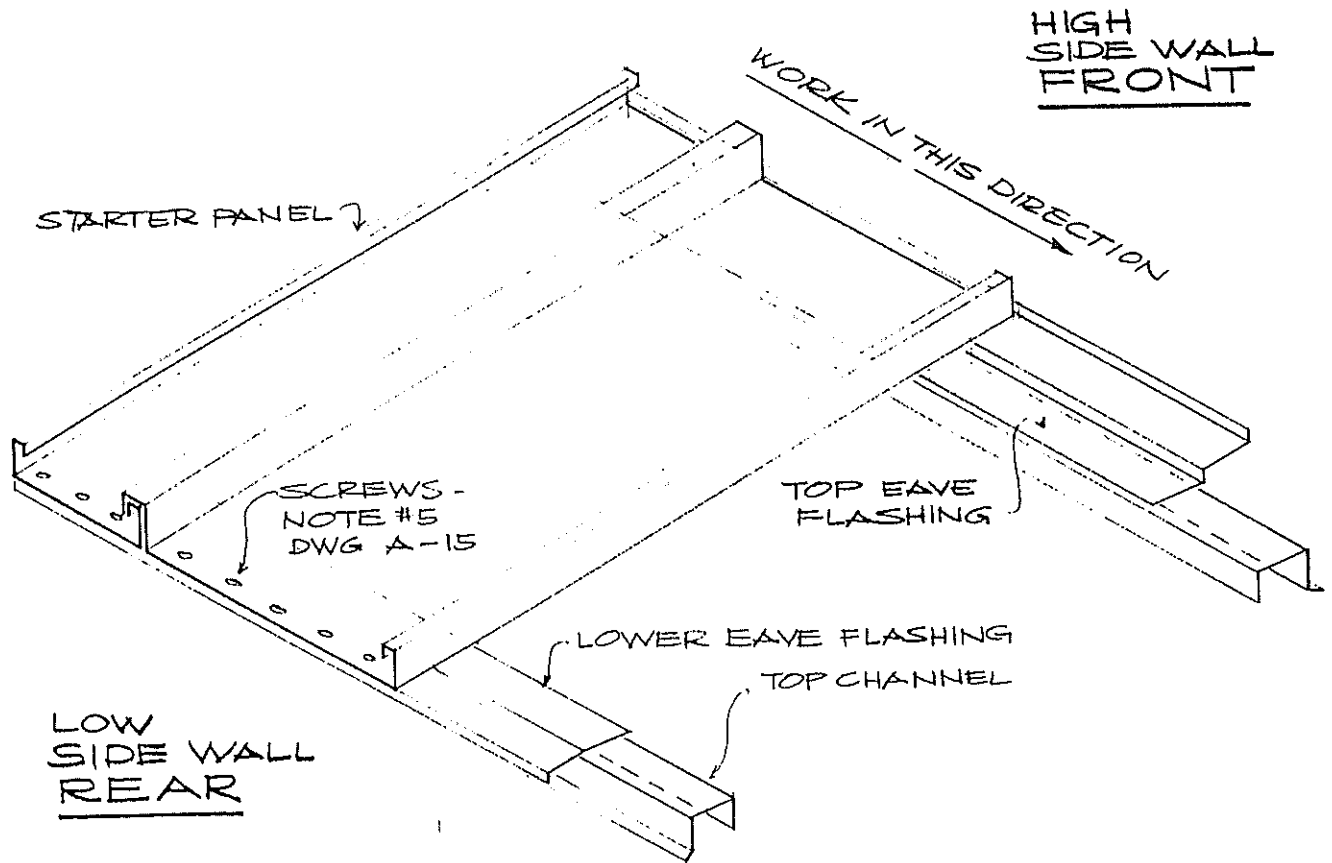

3. WHEN THE STARTER PANEL IS IN PLACE, CONTINUE PLACING ROOF PANELS BUT BE SURE PANELS ARE TOGETHER SNUGLY BEFORE SCREWING. PERIODICALLY CHECK FOR SQUARENESS.

BIG FOOT METAL SYSTEMS LTD. BROOKS, ALBERTA	DR'N BY <i>M</i>	SCALE N.T.S.
TITLE : SHED ROOF ASSEMBLY	DATE APRIL/86	DWG. NO. A-10
TEL. NO. 362-4181		

4. ENDWALL FLASHING .

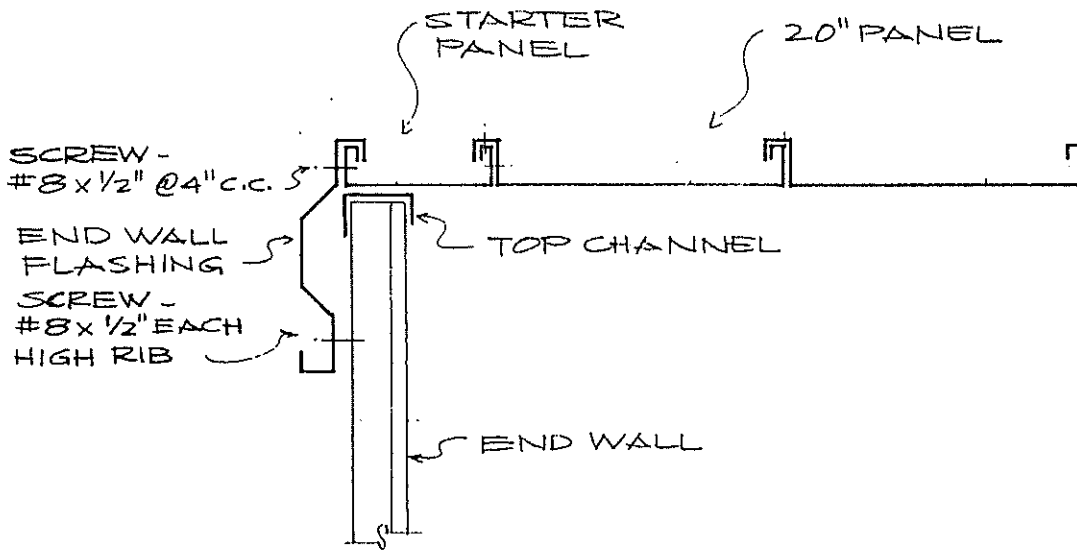

5. NOTE : EAVESTROUGH (OPTIONAL)

DEPENDING ON THE LENGTH OF OVERHANG ,THE EAVES-TROUGH MAY HAVE TO BE INSTALLED BETWEEN THE ROOF PANEL AND REAR TOP CHANNEL FLASHING. THEREFORE, IT WILL HAVE TO BE PLACED SIMULTANEOUSLY WITH THE ROOF PANEL.

* DOWNSPOUT NOT SUPPLIED.
INSTALL ENDCAPS WITH 2-#8 x 1/2" SCREWS.

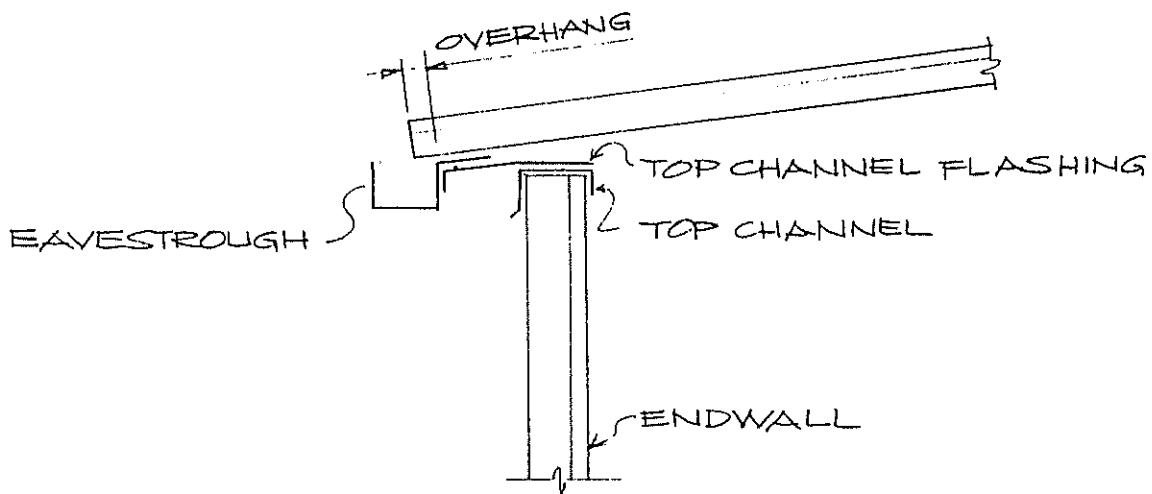

BIG FOOT METAL SYSTEMS LTD.
BROOKS, ALBERTA TEL.NO.362-4181

DR'N BY
M

SCALE
N.T.S.

TITLE :
SHED
ROOF ASSEMBLY

DATE
APRIL/86

DWG. NO.
A-11

WINDOW INSTALLATION :

1. REFER TO MANUFACTURER'S WALL PANEL LAYOUT DRAWING SUPPLIED WITH BUILDING FOR WINDOW LOCATION.
2. ASSEMBLE FULL LENGTH WALL PANELS UP TO WINDOW OPENING.
3. INSTALL SHORT LOWER WALL PANELS BELOW WINDOW.
4. INSTALL WINDOW FRAME (WITHOUT GLASS).
5. ASSEMBLE FULL LENGTH WALL PANEL TO RIGHT OF WINDOW.
6. ASSEMBLE SHORT WALL PANELS ABOVE WINDOW.
7. INSTALL DRIP CAP ACROSS TOP OF WINDOW AND CAULK.

NOTE :

FOR WINDOWS NOT MANUFACTURED BY "ARMOR" A FRAME MUST BE ASSEMBLED IN THE FIELD. USE SPECIAL D-CHANNEL SUPPLIED. CONSTRUCT FRAME ALL AROUND WINDOW OPENING. MITER THE CORNERS. OPENING SHOULD ALLOW $\frac{3}{8}$ " GAP ALL AROUND.

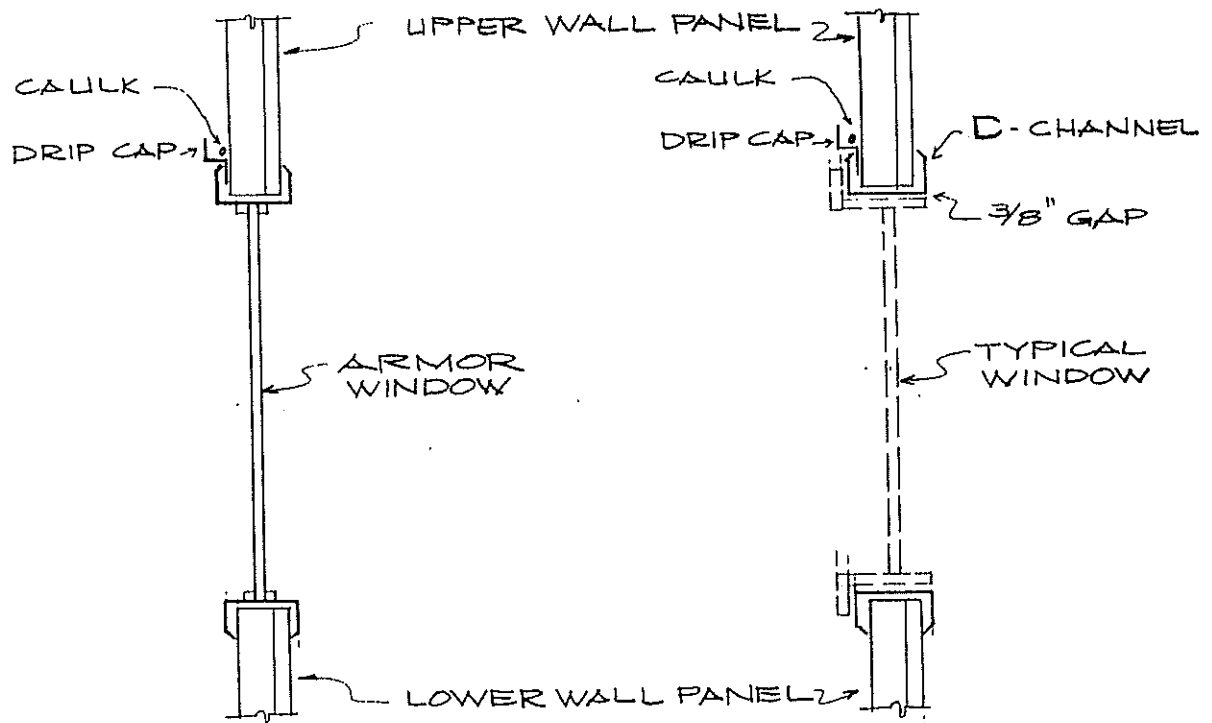

SECTION THRU WINDOWS

BIG FOOT METAL SYSTEMS LTD. BROOKS, ALBERTA	DR'N BY JM	SCALE N.T.S.
TITLE: GABLE AND SHED WINDOWS	DATE APRIL/80	DWG. NO. A-12

WALK DOOR INSTALLATION :

1. REFER TO MANUFACTURER'S WALL PANEL LAYOUT DRAWING SUPPLIED WITH BUILDING FOR DOOR LOCATION.
2. ASSEMBLE FULL LENGTH WALL PANELS UP TO DOOR OPENING.
3. INSTALL DOOR FRAME (WITHOUT DOOR).
4. ASSEMBLE FULL LENGTH WALL PANEL TO RIGHT OF DOOR.
5. ASSEMBLE SHORT UPPER WALL PANELS ABOVE DOOR.
6. INSTALL DRIP CAP AND CAULK.
7. SCREW AS REQUIRED WITH # 14 x 1 1/4" SCREWS (APPROX. 24" C.C.)

NOTE :
 FOR DOORS NOT MANUFACTURED BY "ARMOR"
 A FRAME SUPPLIED WITH THE DOOR MUST BE USED.

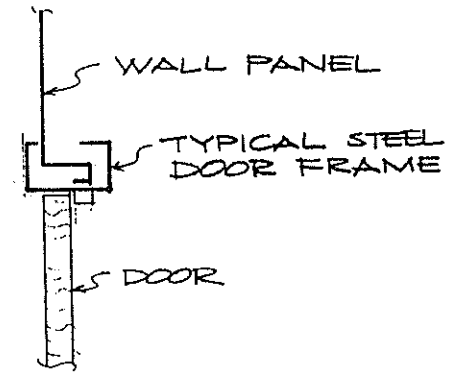

TOP VIEW

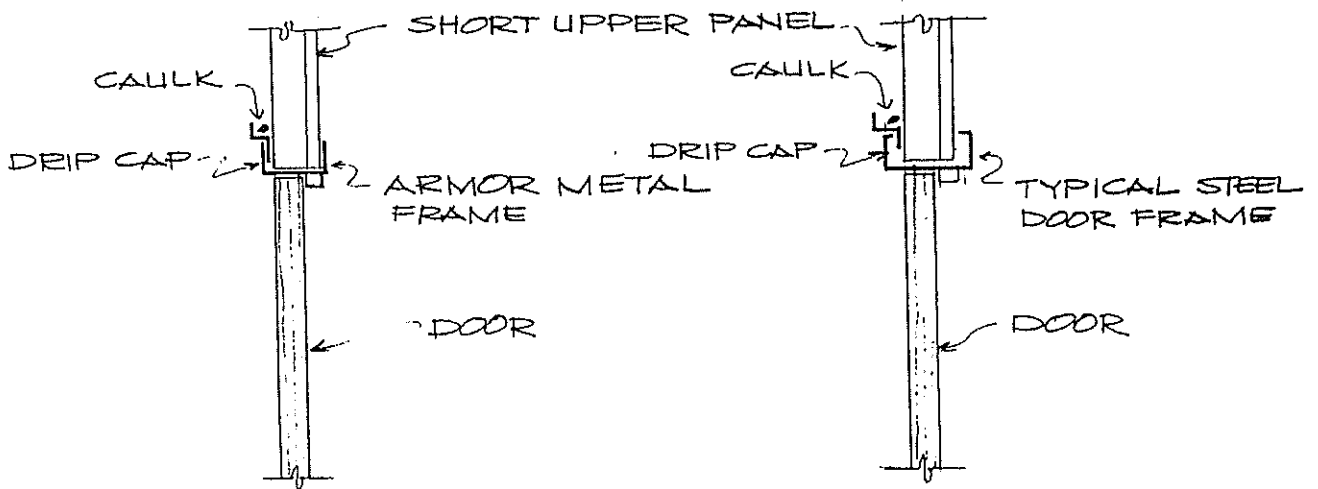

SECTION THRU DOOR

BIG FOOT METAL SYSTEMS LTD. BROOKS, ALBERTA		DR'N BY JM	SCALE N.T.S.
TEL. NO. 362-4181		DATE APRIL / 86	DWG. NO. A-13
TITLE: GABLE & SHED WALK DOORS			

OVERHEAD DOORS

1. REFER TO MANUFACTURER'S WALL PANEL LAYOUT DRAWING SUPPLIED WITH BUILDING FOR DOOR LOCATION.
2. ASSEMBLE WALL COMPONENTS AS SHOWN BELOW.
 * DO NOT INSTALL DOOR ITSELF UNTIL BUILDING IS STRUCTURALLY COMPLETE.

TOP VIEW

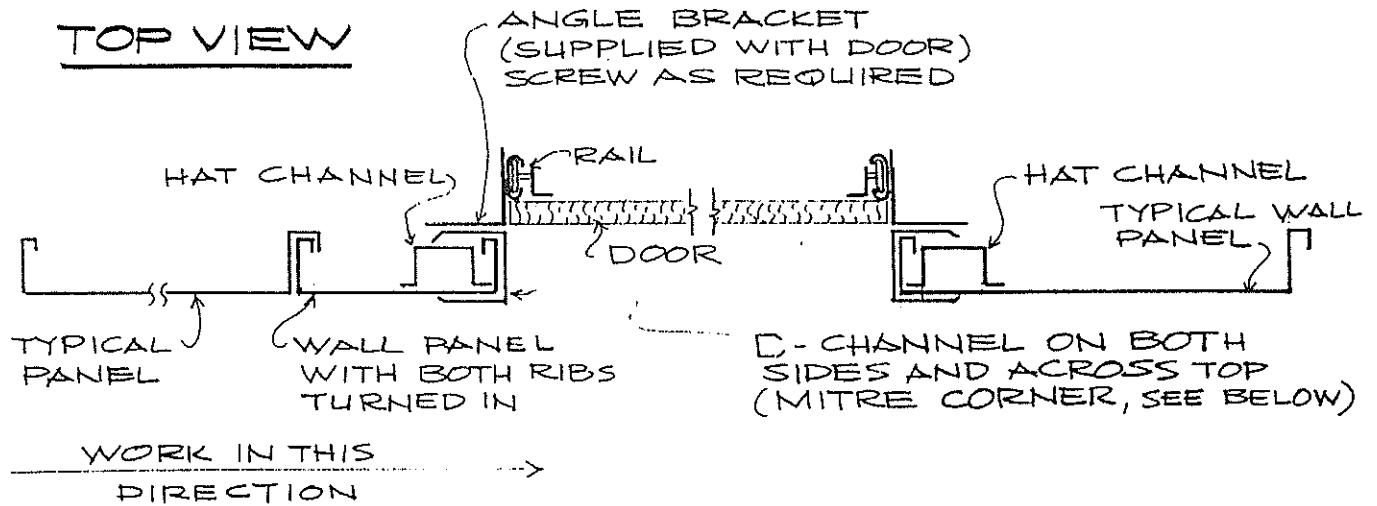

3. IF CENTER MOUNTED SPRING TENSION DEVICE IS USED, INSTALL HAT CHANNEL ACROSS (2) TWO RIBS ON INSIDE, AS FOLLOWS.

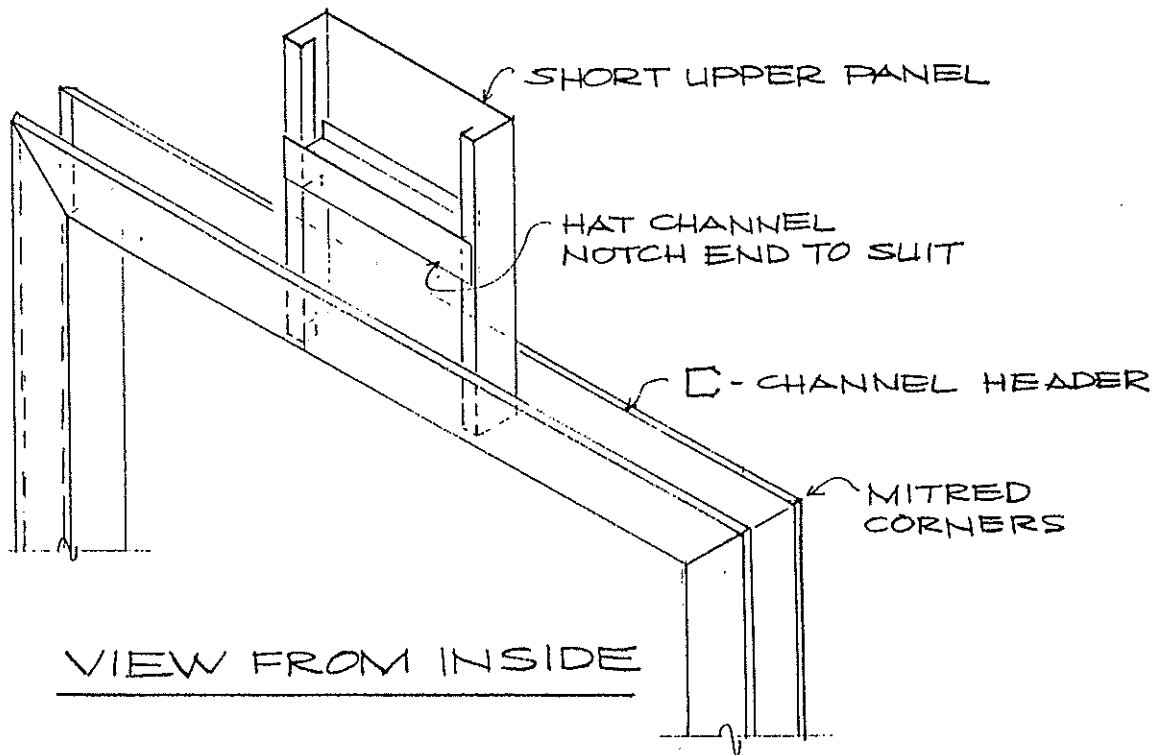

BIG FOOT METAL SYSTEMS LTD.

BROOKS, ALBERTA

TEL. NO. 362-4181

DR'N BY

JL

SCALE

NITS.

TITLE:

**GABLE AND SHED
OVERHEAD DOORS**

DATE

APRIL/86

DWG. NO.

A-14

NOTES :

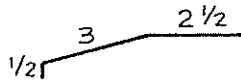

TOP CHANNEL FLASHING

20 GA. GALVANIZED
22 GA. COLORED

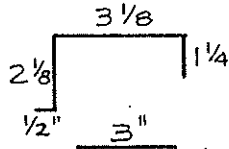

TOP CHANNEL

20 GA. GALV.
22 GA. COLORED

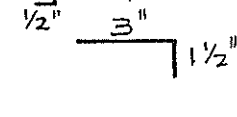

TOP CHANNEL CONNECTOR (8" LONG)

20 GA. GALV.

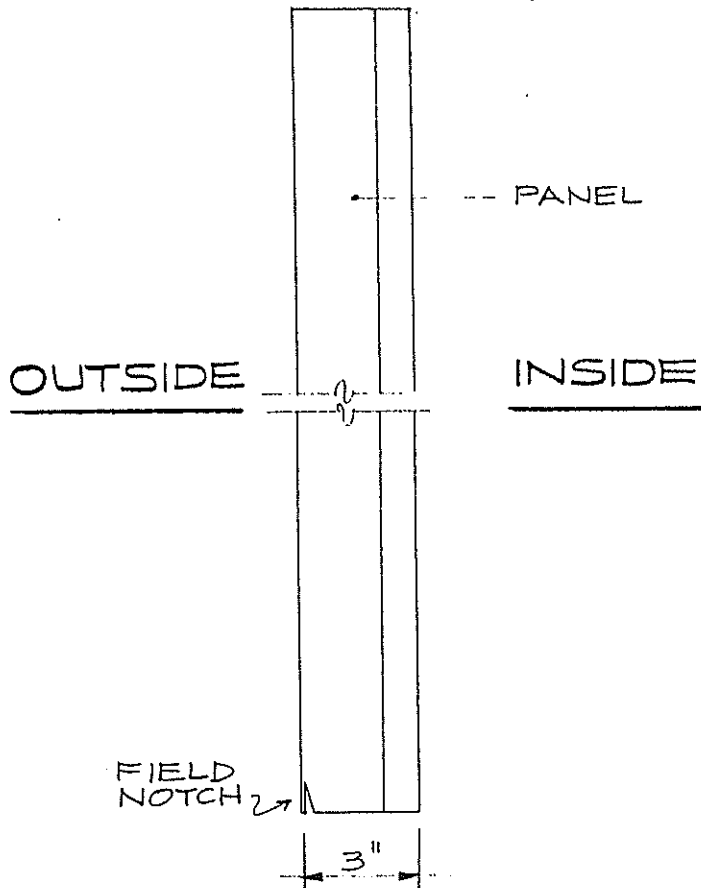

20 GA. GALV.
22 GA. COLORED

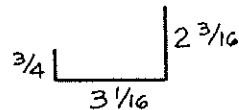

BOTTOM CHANNEL

20 GA. GALV.
NO COLOR

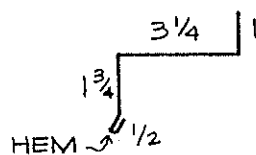

BASE FLASHING

24 GA. GALV.
22 GA. COLORED

BIG FOOT METAL SYSTEMS LTD.
BROOKS, ALBERTA TEL. NO. 362-4181

DR'N BY
M

SCALE
3/16" = 1"

TITLE: GABLE SIDE WALL

DATE
MAR. '86

DWG. NO.
C-1

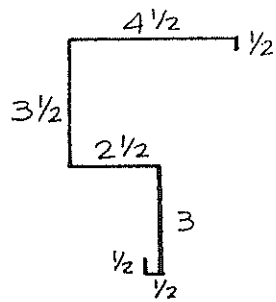

GABLE TRIM

NOTES :

24 GA. GALVANIZED
22 GA. COLORED

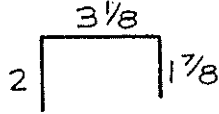

TOP CHANNEL

20 GA. GALV.
NO COLOR



TOP CHANNEL
CONNECTOR
(8" LONG)

20 GA. GALV.



PANEL

20 GA. GALV.
22 GA. COLORED

OUTSIDE

INSIDE

FIELD
NOTCH

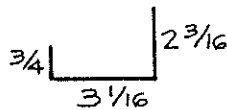

BOTTOM
CHANNEL

20 GA. GALV.
NO COLOR

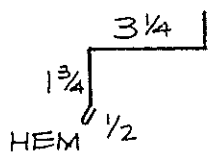

BASE
FLASHING

24 GA. GALV.
22 GA. COLORED

BIG FOOT METAL SYSTEMS LTD.
BROOKS, ALBERTA TEL. NO. 362-4181

DR'N BY
JM

SCALE
3/16" = 1"

TITLE: GABLE
END WALL

DATE
APRIL/86

DWG. NO.
C-2

NOTES :

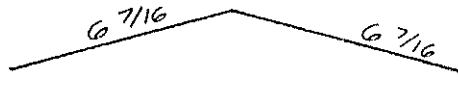

RIDGE CAP CONNECTOR

26 GA. GALV.
22 GA. COLORED

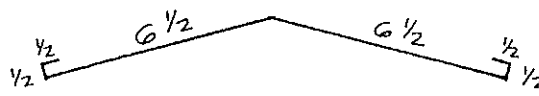

RIDGE CAP

26 GA. GALV.
22 GA. COLORED

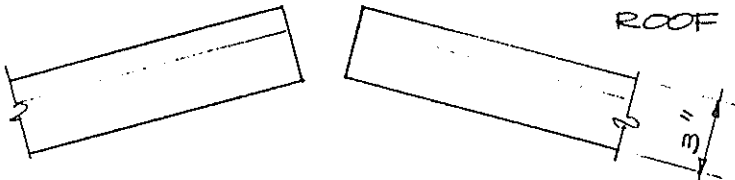

ROOF PANELS

20 GA. GALV.
22 GA. COLORED

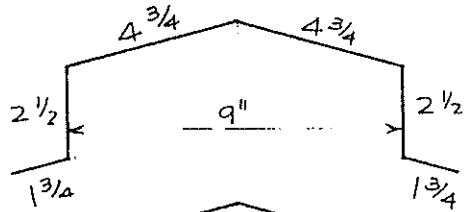

RIDGE CHANNEL

18 GA. GALV. ONLY

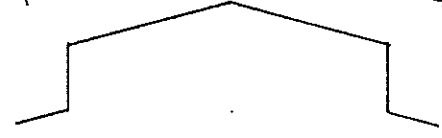

RIDGE CHANNEL CONNECTOR
(36" LONG)
FIT UNDER RIDGE CHANNEL

18 GA. GALV.

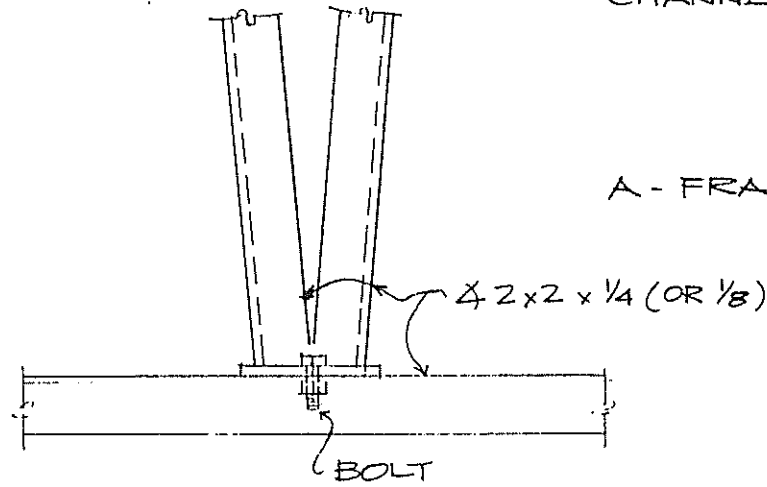

A - FRAME

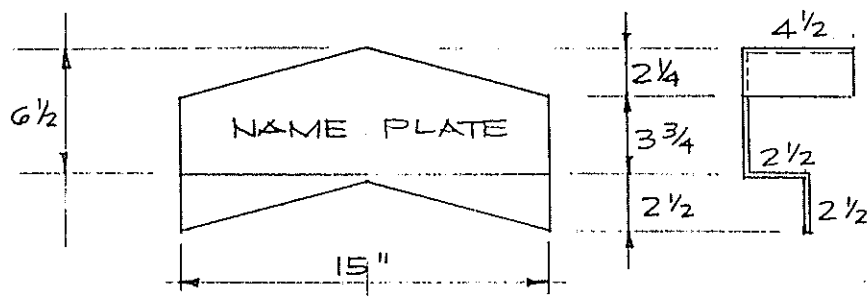

20 GA. GALV.
22 GA. COLORED

BIG FOOT METAL SYSTEMS LTD. BROOKS, ALBERTA TEL. NO. 362-4181		DR'N BY. <i>M</i>	SCALE $\frac{3}{16}'' = 1''$
TITLE: GABLE ROOF		DATE APRIL '80	DWG. NO. C-3

NOTES 1

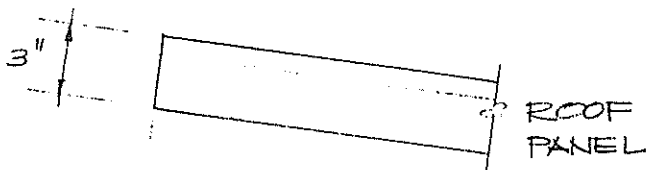

ROOF
PANEL

20 GA. GALV.
22 GA. COLORED

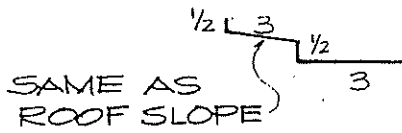

TOP EAVE
FLASHING

20 GA. GALVANIZED
22 GA. COLORED

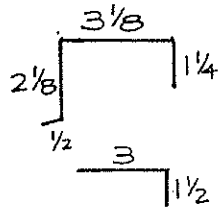

TOP
CHANNEL

20 GA. GALV.
22 GA. COLORED

TOP CHANNEL
CONNECTOR
(8" LONG)

20 GA. GALV.

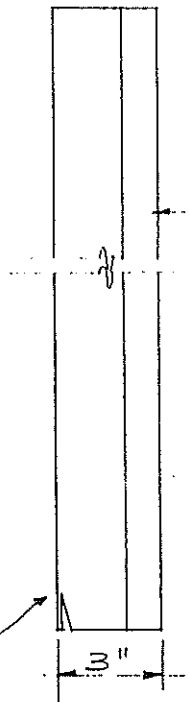

WALL
PANEL

20 GA. GALV.
22 GA. COLORED

OUTSIDE

INSIDE

FIELD
NOTCH

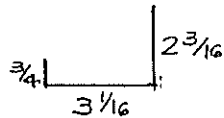

BASE
CHANNEL

20 GA. GALV.
NO COLOR

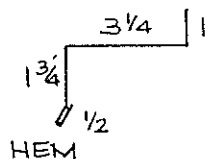

BASE
FLASHING

24 GA. GALV.
22 GA. COLORED

BIG FOOT METAL SYSTEMS LTD.

BROOKS, ALBERTA

TEL. NO. 362-4181

DR'N BY
M

SCALE
3/16" = 1"

TITLE:

SHED
HIGH SIDE WALL

DATE
APRIL / 86

DWG. NO.
C-4

NOTES :

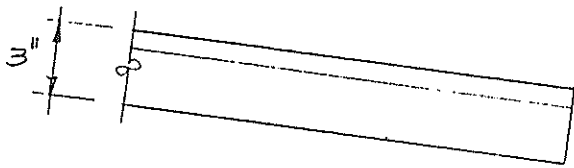

ROOF
PANEL

20 GA. GALV.
22 GA. COLORED

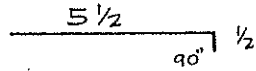

LOWER EAVE
FLASHING

20 GA. GALVANIZED
22 GA. COLORED

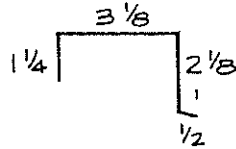

TOP
CHANNEL

20 GA. GALV.
22 GA. COLORED

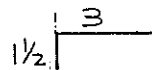

TOP CHANNEL
CONNECTOR
(8" LONG)

20 GA. GALV.

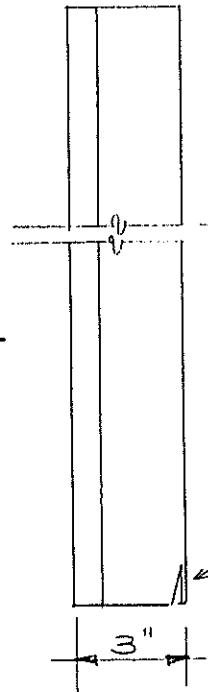

WALL
PANEL

20 GA. GALV.
22 GA. COLORED

INSIDE

OUTSIDE

FIELD
NOTCH

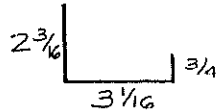

BASE
CHANNEL

20 GA. GALV.
NO COLOR

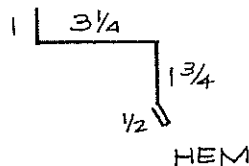

BASE
FLASHING

24 GA. GALV.
22 GA. COLORED

HEM

BIG FOOT METAL SYSTEMS LTD.

BROOKS, ALBERTA

TEL. NO. 362-4181

DR'N BY

M

SCALE

$\frac{3}{16}'' = 1''$

TITLE:

SHED
LOW SIDE WALL

DATE

APRIL/86

DWG. NO.

C-5

NOTES :

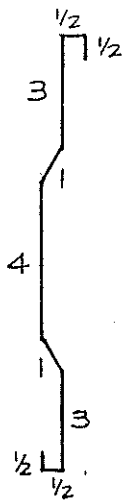

TOP FLASHING

24 GA. GALVANIZED
22 GA. COLORED

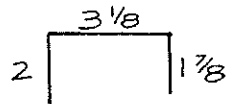

TOP CHANNEL

20 GA. GALV. ONLY



TOP CHANNEL CONNECTOR
(8" LONG)

20 GA. GALV.

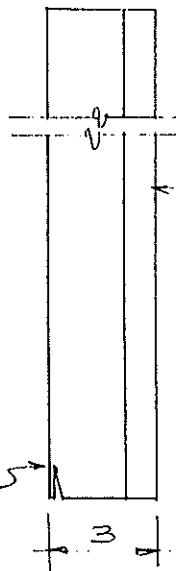

WALL PANEL

20 GA. GALV.
22 GA. COLORED

OUTSIDE

INSIDE

FIELD NOTCH

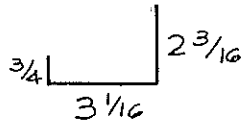

BASE CHANNEL

20 GA. GALV.,
NO COLOR

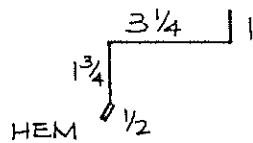

BASE FLASHING

24 GA. GALV.
22 GA. COLORED

BIG FOOT METAL SYSTEMS LTD.
BROOKS, ALBERTA TEL. NO. 362-4181

DR'N BY
JM

SCALE
3/16" = 1"

TITLE: SHED
END WALL

DATE
APRIL/86

DWG. NO.
C-6

NOTES:

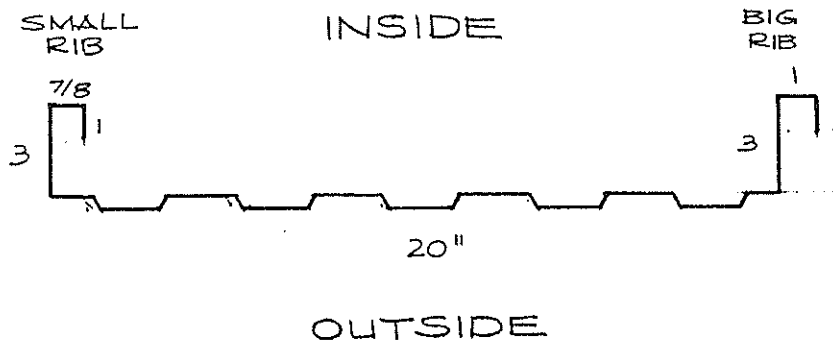

20 GA. GALV.
22 GA. COLORED

WALL PANEL

NOTES:

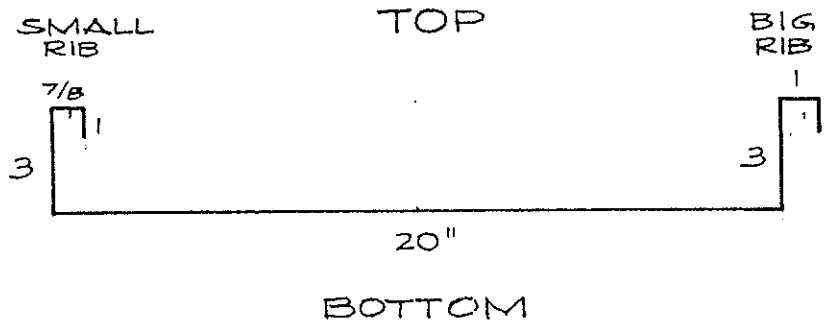

20 GA. GALV.
22 GA. COLORED

ROOF PANEL

NOTES:

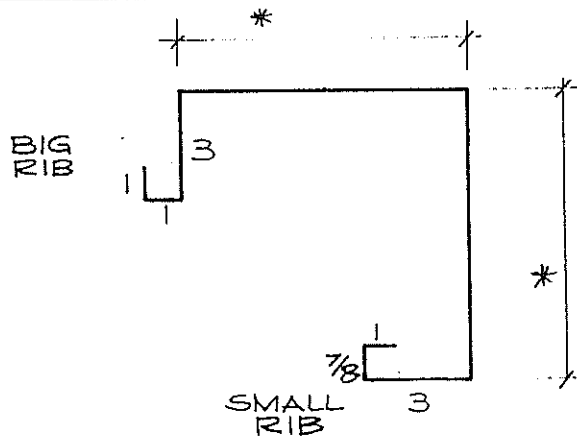

20 GA. GALV.
22 GA. COLORED

* - DIMENSION
TO SUIT

CORNER PANEL

BIG FOOT METAL SYSTEMS LTD.
BROOKS, ALBERTA

TEL. NO. 362-4181

DR'N BY
JM

SCALE
3/16" = 1"

TITLE: GABLE AND SHED
ROOF, WALL, CORNER PANELS

DATE
APRIL/86

DWG. NO.
C-7

NOTES :

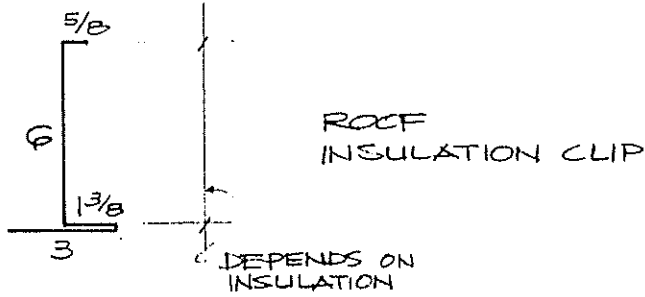

ROOF
INSULATION CLIP

28 GA. GALVANIZED

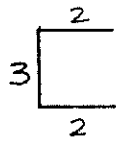

ENDWALL
INSULATION
CHANNEL

28 GA. GALV.

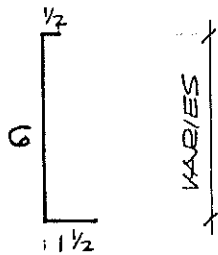

ROOF LIGHT
INSULATION CLIP

28 GA. GALV.

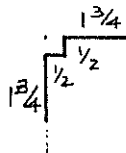

LINER
CORNER FLASHING

24 GA. GALV.

BIG FOOT METAL SYSTEMS LTD;

BROOKS, ALBERTA

TEL. NO. 362-4181

DR'N BY

JL

SCALE

3/16" = 1"

TITLE:

GABLE AND SHED
ACCESSORY COMPONENTS

DATE

APRIL/86

DWG. NO.

C-9